

Concept Panelboards

An extensive and flexible range of panelboards to suit your various application needs

POWER DISTRIBUTION AND PROTECTION



NHP's Concept panelboard range

The Concept range has a panelboard model to suit just about all applications, from standard configuration to a unique design. NHP's new design tool Xpress ProDesigner (XPD) can turn around a specific request into custom design within minutes. XPD linked to NHP's national manufacturing centre can successfully deliver a custom engineered solution from end to end.

- Personalised end-to-end manufacturing service with a dedicated project team
- Engineered solutions delivering quality, reliability and performance
- State of the art manufacturing facility operated by highly skilled personnel

NHP's national manufacturing and distribution centre in Laverton, Victoria highlights NHP's commitment in local manufacturing and expertise. At this state of the art facility our expert team brings together a range of manufacturing solutions under one roof, enabling us to provide you with what you want, when you want it.

With interactive tours of the manufacturing and distribution facility available, visitors are able to view and experience the cutting edge technology and quality product that is brought to life at the facility (note tours available by appointment only).

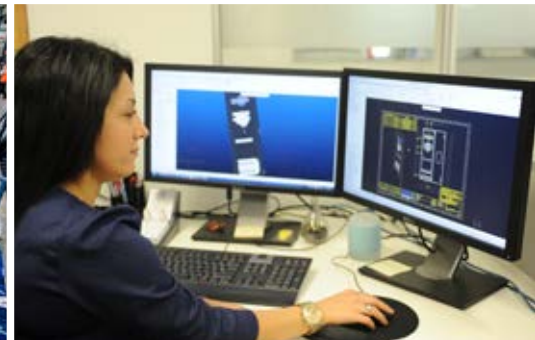
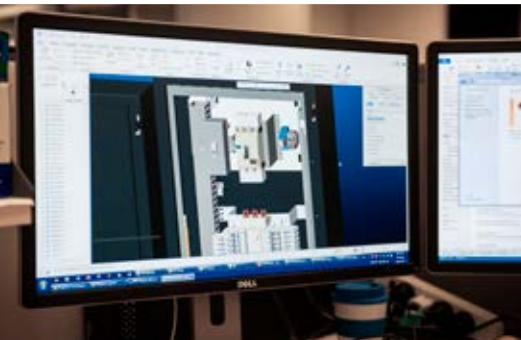
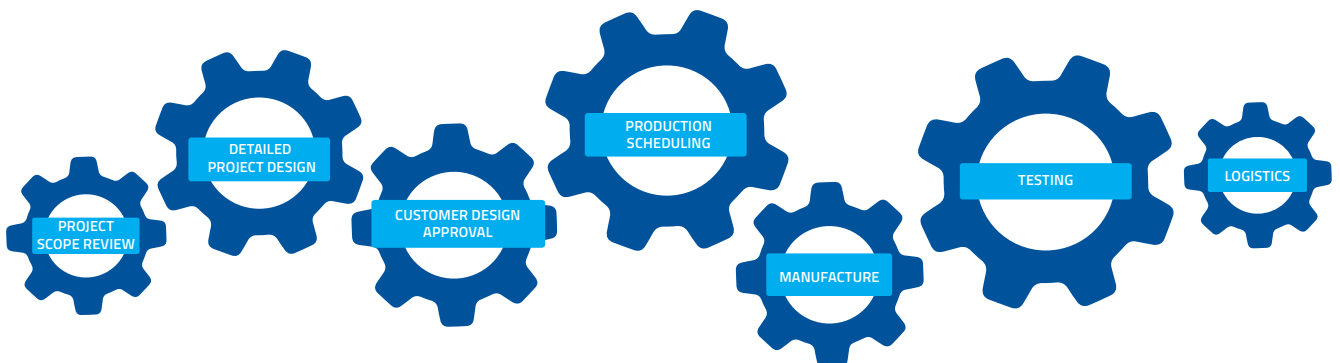

Contents

Page

Top 10 reasons to use Concept panelboards

4

Selection Tables

6



Concept One

The essential panelboard

9

The Concept One panelboard is the first in the Concept range offering core range of essential features. Concept One offers compact enclosure with a neutral finish to blend in.



Concept Plus

The multipurpose panelboard

13

The Concept Plus panelboard is a multipurpose panelboard for general purpose applications offering large range of features and options. Concept Plus offers IP42 rating with option IP52.



Concept Premier

The premium panelboard

23

The Concept Premier panelboard is a premium panelboard offer all the feature of Concept Plus but also includes additional features such as IP66 rating, 3 point door locking and stainless steel option. The increased depth between escutcheon and door allows load break handles and locking devices to be fitted



Concept Tough

The heavy duty panelboard

33

The Concept Tough panelboard range is constructed from fully welded 2mm mild steel or 316 marine grade stainless steel for those extra tough environments. Concept Tough has all the features of Concept Premier plus more including an increase in depth, width and material thickness for extra strength.



Concept Accessories

General range of accessories that suits Concept panelboards such as schedule cards, spare keys, touch up paint and earth and neutral bars

37



Concept Technical

Dimension diagrams including mounting dimensions

41

Top 10 reasons to use Concept Panelboards



1. Cable management

- Support brackets with built in tie down points for better cable management
- Rolled edged to prevent damage to cables
- Plenty of wiring room
- Allows quicker and neater install



2. IP2X touch protection

- Helps prevent accidental contact with live conductors
- Fully shrouded connections between main switch and busbar chassis
- Encapsulated busbar style chassis with tee-off caps covering live tee-offs



3. Handle locking options

- Semi flush swing handle– increased vandal resistance, helps pre-vent being caught on when boards are mounted in hallways
- Different locking options CL001, 92268, pad lockable, non-locking, E-Key options, 8mm square. Simply remove and replace handle
- Stainless steel handle options
- Smoother closing action with use of 3 point roller cam
- No more scraping metal edges and potential paint damage



4. Inter changeable main switch

- Main Switch can be retro fitted with either isolator or MCCB in the field
- Isolator can be pad locked as standard in off
- MCCB can be padlocked with captive accessory or non-captive accessory



5. Pad locked devices with door closed

- The door can now be closed with padlocked devices such as; main isolator, main switch MCCB, load-break switches and MCBs
- Increased depth between door and escutcheon

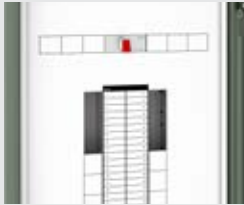

6. Din knockouts

- Quickly add accessory items by knocking out built in knockout in the escutcheon
- No need to use pole fillers
- No more lost pole fillers



7. Hinged escutcheon

- In Concept Plus and Concept Premier the escutcheon is hinged as standard
- Escutcheon is easily removed



8. Tough paint finish

- New textured paint finish to hide damage that often occurs during handling and installation
- Help prevent scuff marks and hides finger marks



9. New true modular system

- Height of boards are made to true modular system based on 216mm modules
- Allow different size boards to be joined or mounted side by side.

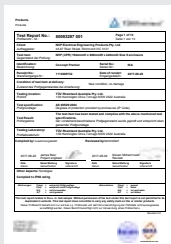

10. Genuine IP ratings

- Range tested by 3rd party, NATA accredited test station
- Piece of mind ratings

Panelboard features

Series	Concept One COE	Concept Plus CPL	Concept Premier CPR	Concept Tough CTD
IP rating (option)	IP40	IP42 (IP52)	IP66	IP66
Width	530mm	600mm	600mm	800mm
Depth (including door)	153mm*	200mm*	240mm*	324mm*
Mild steel colours	Light grey RAL7035	N42 Storm grey X15 Orange	N42 Storm grey X15 Orange	X15 Orange
Stainless steel colours	-	-	X15 Orange Natural (No4)	X15 Orange Natural (brushed)
Material mild steel	1mm	1.6mm	1.6mm	2.0mm
316 Stainless steel	-	-	1.6mm	2.0mm
MCB type	MOD6/ DIN-T	DIN-T	DIN-T	DIN-T
MCB chassis type	Encapsulated	NC encapsulated GB-Isolation option	NC encapsulated GB-Isolation option	NC encapsulated GB-Isolation option
MCB chassis rating	250A	250A, 400A	250A, 400A	250A, 400A
MCB pole capacity	24-84	24-96	24-96	24-96
Spare horizontal DIN spaces	16	18	18	18
Isolator main switch	160A, 250A	160A, 250A, 400A	160A, 250A, 400A	160A, 250A, 400A
MCCB main switch	160A, 200A	160A, 200A, 300A	160A, 200A, 300A	160A, 200A, 300A
MCCB type (Terasaki)	-	-	125AF, 250AF	125AF, 250AF
MCCB chassis type	-	-	XA, XB	XA, XB
MCCB chassis rating	-	-	630A, 800A	630A, 800A
MCCB pole capacity	-	-	6-72	6-72
Door hinged	RH	RH	RH	RH
Escutcheon hinged	No	Standard	Standard	Standard
White escutcheon	Standard	Standard	Standard	Standard
Door handle	Semi flush swing handle	Semi flush swing handle	Semi flush swing handle	L Handle
3 Point locking	-	Option	Standard	Standard
Door lock CL001	Standard	Standard	Standard	-
Door lock 92268	Option	Option	Option	-
Door lock non-locking	Option	Option	Option	-
PWD lock "E-Lock"	Option	Option	Option	-
Pad lockable	Option	Option	Option	Standard
Special colours	Special order	Special order	Special order	Special order
Rainhood cover	-	-	Option	Standard
Plinth	-	Option	Option	Option
Flush mounting kit	Option	Option	Option	-
Wall mounting brackets	-	Option	Option	Standard
Removable gland-plates	Option	Standard	Standard	Standard
Gland-plates brass/aluminium	-	Option	Option	Aluminium standard
Pages	9-12	13-22	23-32	33-35

*excluding door handle

Selection table

Series	Concept One COE	Concept Plus CPL	Concept Premier CPR	Concept Tough CTD
MCB Chassis				
250A Chassis				
No main-switch	Standard	Standard	Standard	Standard
Captive locking "LOCKDIN"	-	-	Option	Option
Extra row DIN rail 24W "X-Row"	-	Standard	Option	Option
Isolation chassis "GB"	-	Standard	Option	Option
Isolation chassis "GB" captive locking	-	-	Option	Option
Split chassis	-	Option	Option	Option
Single energy meter, Isolator 160-250A	-	Standard	Option	Option
Dual energy meter, Isolator 160-250A	-	Standard	Option	Option
250A Chassis main-switch options				
Isolator 160A	Standard	Standard	Standard	Standard
Isolator 250A	Standard	Standard	Standard	Standard
S160NJ MCCB 100-160A	Standard	Standard	Standard	Option
S250NJ MCCB 160-200A	Standard	Standard	Standard	Option
400A Chassis				
No main-switch	-	Option	Option	Option
Hybrid chassis 27 & 18mm pitch	-	Option	Option	Option
400A Chassis main switch options				
Isolator 160A	-	Option	Option	Option
Isolator 250A	-	Option	Option	Option
Isolator 400A	-	-	Option	Option
S160NJ MCCB 100-160A	-	Option	Option	Option
S250NJ MCCB 160-200A	-	Option	Option	Option
S400NE MCCB 250-400A	-	-	Option	Option
MCCB Chassis				
630A XA Chassis, 125AF	-	-	Option	Option
800A XB Chassis, 160AF & 250AF	-	-	Option	Option
MCCB Chassis main switch options				
Isolator 400A	-	-	Option	Option

Safe, Secure, Compact, Reliable

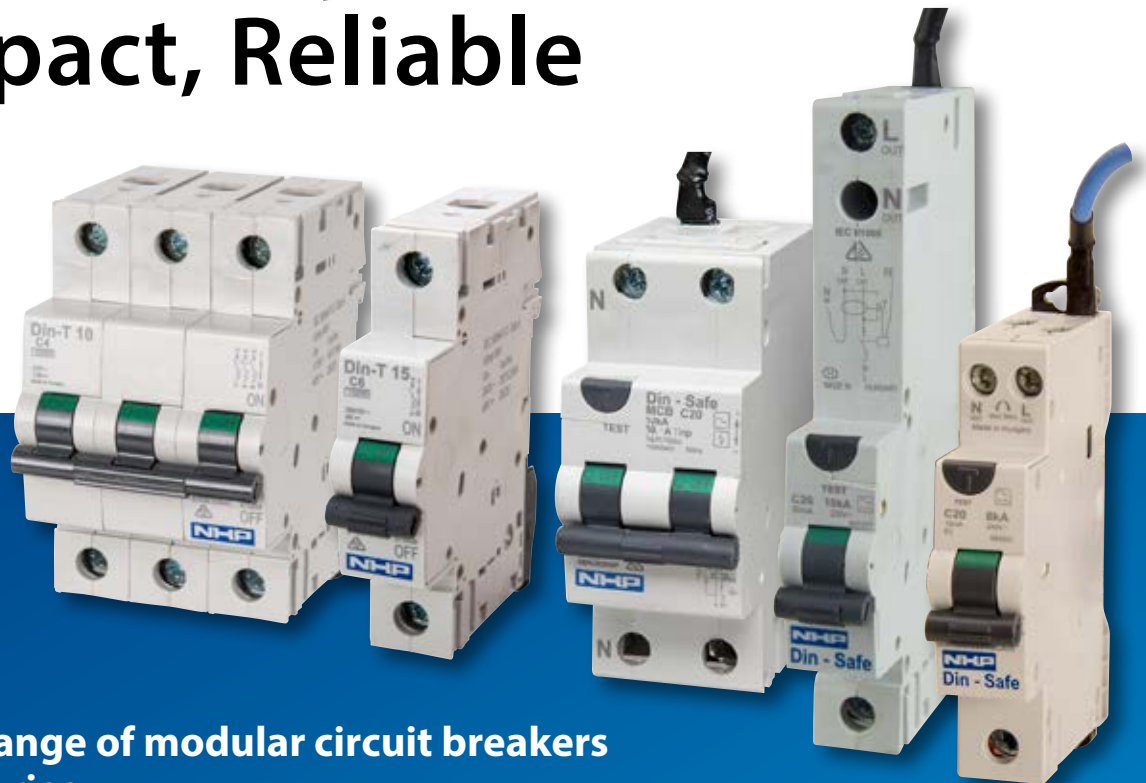

Complete range of modular circuit breakers and accessories

NHP DIN-T a complete range of circuit protection devices and associated accessories. The NHP DIN-T range offers an extensive and flexible product that meets the needs of the ever changing demands of switchboard design.

NHP Din-T range

- Miniature circuit breakers (MCBs)
 - 6kA, 10kA and 15kA
 - 1P, 2P, 3P and 4P
 - 0.5A-125A
- Residual current circuit breakers (RCBOs)
 - 6kA and 10kA
 - 1P, 2P, 3P and 3P+N
 - 10mA, 30mA, 100mA, 300mA
 - 6A-40A
- Residual Current Device (RCCBs, RCDs)
 - 2P - 3P+N
 - 30mA, 100mA, 300mA
 - 40A-125A
- Accessory devices
 - Shunt Trip
 - Under voltage trip
 - Motor operators
 - Busbar combs
 - Pin terminal
 - Terminal shrouds
 - Lock off devices

When compared to traditional circuit breakers, the DIN-T range of devices under short circuit conditions have very quick operational times, typically 2mS, resulting in very low energy let-through values, minimising damage to downstream cables and devices and as a result increasing their operational life.

Concept One

The essential panelboard - for MOD6 or DIN-T MCBs



Concept One

The essential panelboard - for MOD6 or DIN-T MCBs



Domestic and commercial applications

- Neutral finish with RAL7035 light grey colour to blend into background for commercial applications.
- Gloss white lift off escutcheon that is independent from the door
- Knockouts in the escutcheon for up to 16 modules of extra DIN rail equipment
- 5 enclosure sizes 432mm-1296mm high
- Door hinged right-hand side
- Semi flush door swing handle with various door locking options
- Compact main-switch options 160A or 250A isolator or 100-200A MCCB
- Earth and Neutral bar, circuit identification and schedule cards as standard
- Semi concealed door hinges



Material type	1.0 mm Steel enclosure 1.0 mm Steel escutcheon
Finish	Textured polyester powder coated
Colour	Enclosure –Light Grey (RAL7035) Escutcheon– Bright White gloss

Protection degree	IP30 without door IP40 with door
--------------------------	-------------------------------------

Busbar ratings	Current rating 250A I_{cw} 25kA 0.1s & 10kA 1.0s
-----------------------	---

Neutral & earth bar	Current rating 250A M8 stud top and bottom Spare 1x16mm ² & 1x25mm ² tunnels QTY 2 x 25mm ² tunnels Balance 16mm ² tunnels Tunnels 2 screw
--------------------------------	---

Main switch	Isolator 160A Isolator 250A MCCB S160NJ (100-160A) MCCB S250NJ (160-200A)
--------------------	--



Concept One Panelboards



Pole Capacity	Module Size	Height (mm)	Catalogue No.
---------------	-------------	-------------	---------------

No Main Switch

24	3	648	COE-24-LG
36	4	864	COE-36-LG
48	4	864	COE-48-LG
60	5	1080	COE-60-LG
84	6	1296	COE-84-LG

160A Main Switch

24	3	648	COE-24M160-LG
36	4	864	COE-36M160-LG
48	4	864	COE-48M160-LG
60	5	1080	COE-60M160-LG
84	6	1296	COE-84M160-LG

250A Main Switch

24	3	648	COE-24M250-LG
36	4	864	COE-36M250-LG
48	4	864	COE-48M250-LG
60	5	1080	COE-60M250-LG
84	6	1296	COE-84M250-LG

160A Main Switch (MCCB adjustable 100-160A)

24	3	648	COE-24MCCB160-LG
36	4	864	COE-36MCCB160-LG
48	4	864	COE-48MCCB160-LG
60	5	1080	COE-60MCCB160-LG
84	6	1296	COE-84MCCB160-LG

200A Main Switch (MCCB adjustable 160-200A)

24	3	648	COE-24MCCB200-LG
36	4	864	COE-36MCCB200-LG
48	4	864	COE-48MCCB200-LG
60	5	1080	COE-60MCCB200-LG
84	6	1296	COE-84MCCB200-LG

Width 530mm Depth 153mm includes door (20mm) excluding door handle

Concept One Accessories



Accessory Module-DIN cut-out

Pole Capacity	Module Size	Height (mm)	Catalogue No.
21	2	432	COEACC-21-LG
42	2	432	COEACC-42-LG
63	3	648	COEACC-63-LG

Accessory Module-Bank Escutcheon

-	2	432	COEACC-2ME-LG
-	3	648	COEACC-3ME-LG

Width 530mm Depth 153mm includes door (20mm) excluding door handle

Description	Module size	Height (mm)	Catalogue No.
-------------	-------------	-------------	---------------

General Accessories

White gear tray	2	395	COEGT-2M
White gear tray	3	611	COEGT-3M
Flush kit	3	648	COEFK-3MLG
Flush kit	4	864	COEFK-4MLG
Flush kit	5	1080	COEFK-5MLG
Flush kit	6	1296	COEFK-6MLG

Description	Catalogue No.
-------------	---------------

Emergency lighting test kit rotary switch (prewired)	CPELK1W
Emergency lighting test kit key switch	CPELK2
External light control kit on-off-auto1CH 2N/O 25A	CELEXTLKC
External light control kit on-off-auto1CH 2N/O 25A	CELEXTLK1
External light control kit on-off-auto 2CH 4N/O 25A	CELEXTLK2
Surge Kit 40KA MCB + surge type 2 + Loom	CELSURGEK1
Door swing handle CL001	CELHDSpsc
Door swing handle 92268	CELHDSps9
Door swing handle padlockable	CELHDSppp

Main-Switch Kits

Isolator switch kit 160A 3P	CEL3160
Isolator switch kit 250A 3P	CEL3250
MCCB S160NJ main switch kit 3P (Adjustable 100-160A)	CELMCCB3160
MCCB S250NJ main switch kit 3P (Adjustable 160-200A)	CELMCCB3200

Gland-plates

Solid end cap	CECEECMSG
Open end cap	COEEOEC
Gland-plate to suit open end cap	COEGP

Concept Plus

The multipurpose panelboard - for DIN-T MCBs

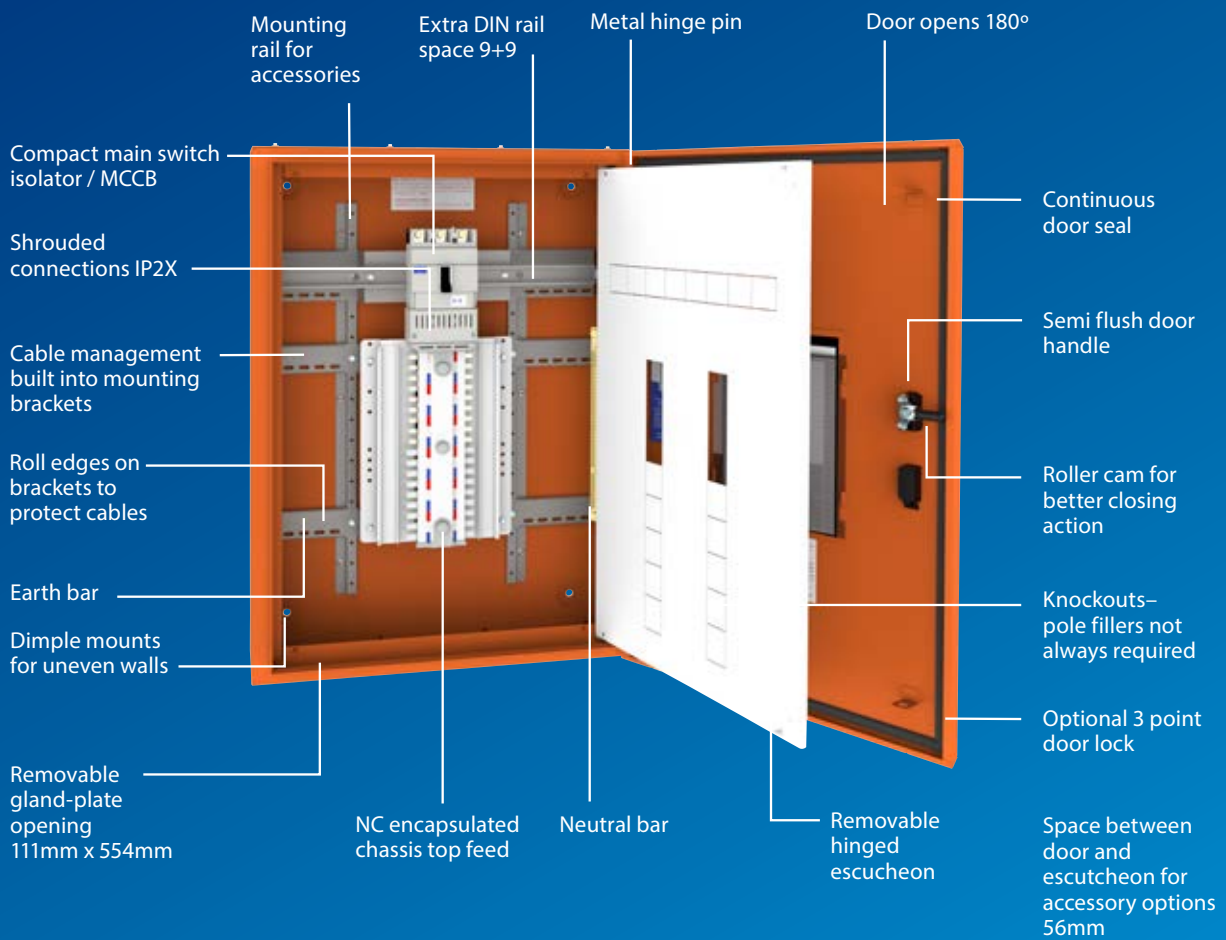

Concept Plus

The multipurpose panelboard for DIN-T MCBs

Commercial and industrial applications

- IP42 rating, optional kit for IP52 rating
- Grey or Orange colour options
- 1.6mm fully welded construction
- Gloss white removeable hinged escutcheon that is independent from the door
- Knockouts in the escutcheon for up to 18 modules of extra DIN rail equipment
- 8 modular sizes cover the range from 24-96pole (432mm-1944mm)
- Door hinged right-hand side
- Semi flush door swing handle with various door locking options
- Compact main-switch options 160A or 250A isolator or 100-200A MCCB
- Earth and Neutral bars, circuit identification and schedule cards included as standard
- Semi concealed door hinges



Material type	1.6mm Steel enclosure 1.0/1.2mm Steel escutcheon
Finish	Textured polyester powder coated
Colour	Enclosure – Grey (N42 storm grey) Enclosure – Orange (X15) Escutcheon– Bright White gloss
Protection degree	IP30 without door IP42 with door (option IP52)
Busbar ratings	Current rating 250A (option 400A) NC 250A I _{cw} 25kA 0.1s, 20kA 0.3s & 10kA 1.0s NC 400A I _{cw} 30kA 0.1s, 25kA 0.3s GB 250A I _{cw} 25kA 0.1s & 10kA 1.0s
Neutral & Earth Bar (up to 250A DBs)	Current rating 250A M8 stud top and bottom Spare 1x16mm ² & 1x25mm ² tunnels QTY 2 x 25mm ² tunnels Balance 16mm ² tunnels Tunnels 2 screw
Main Switch	Isolator 160A Isolator 250A MCCB S160NJ (100-160A) MCCB S250NJ (160-200A)

Concept Plus

Standard panelboard - CPL

NC 250A busbar chassis top feed 3P

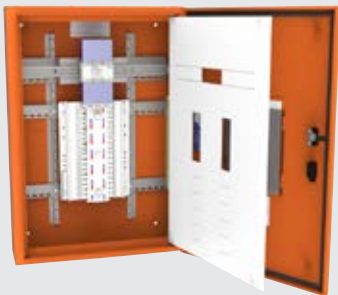

Isolation panelboard - CPLG

Isolation chassis GB 250A busbar chassis top feed 3P,
Busbar tee-off can be isolated prior to fitting or removing MCBs



X-Row panelboard - CPLX

Extra row 24 poles of DIN at bottom of
board for general DIN accessories



Energy metering panelboard - CPLMS

Single energy meter monitoring total panelboard
consumption



Dual energy metering panelboard - CPLMD

Dual energy meter monitoring light and
power circuits separately



For other options contact NHP

- Splits chassis for load shedding or metering
- 400A chassis
- Hybrid chassis suits 80-125A MCBs and 0.5-63A MCBs
- Other main switch options
- Surge protection
- Emergency lighting control

CPL panelboards are available in either grey or orange options.

CPL panelboards can be fitted with 160A or 250A isolator main switch or 160A or 200A MCCB main switch.*

*excludes metering CPLM panelboards

Concept Plus Panelboards



Pole Capacity	Module Size	Height (mm)	Catalogue No. Grey	Catalogue No. Orange
---------------	-------------	-------------	--------------------	----------------------

No Main Switch

24	3	648	CPL-24-G	CPL-24-O
36	4	864	CPL-36-G	CPL-36-O
48	4	864	CPL-48-G	CPL-48-O
60	5	1080	CPL-60-G	CPL-60-O
72	6	1296	CPL-72-G	CPL-72-O
84	6	1296	CPL-84-G	CPL-84-O
96	7	1512	CPL-96-G	CPL-96-O

160A Main Switch

24	3	648	CPL-24M160-G	CPL2-4M160-O
36	4	864	CPL-36M160-G	CPL-36M160-O
48	4	864	CPL-48M160-G	CPL-48M160-O
60	5	1080	CPL-60M160-G	CPL-60M160-O



250A Main Switch

24	3	648	CPL-24M250-G	CPL-24M250-O
36	4	864	CPL-36M250-G	CPL-36M250-O
48	4	864	CPL-48M250-G	CPL-48M250-O
60	5	1080	CPL-60M250-G	CPL-60M250-O
72	6	1296	CPL-72M250-G	CPL-72M250-O
84	6	1296	CPL-84M250-G	CPL-84M250-O
96	7	1512	CPL-96M250-G	CPL-96M250-O

160A Main Switch (MCCB adjustable 100-160A)

24	3	648	CPL-24MCCB160-G	CPL-24MCCB160-O
36	4	864	CPL-36MCCB160-G	CPL-36MCCB160-O
48	4	864	CPL-48MCCB160-G	CPL-48MCCB160-O
60	5	1080	CPL-60MCCB160-G	CPL-60MCCB160-O
72	6	1296	CPL-72MCCB160-G	CPL-72MCCB160-O
84	6	1296	CPL-84MCCB160-G	CPL-84MCCB160-O
96	7	1512	CPL-96MCCB160-G	CPL-96MCCB160-O



200A Main Switch (MCCB adjustable 160-200A)

24	3	648	CPL-24MCCB200-G	CPL-24MCCB200-O
36	4	864	CPL-36MCCB200-G	CPL-36MCCB200-O
48	4	864	CPL-48MCCB200-G	CPL-48MCCB200-O
60	5	1080	CPL-60MCCB200-G	CPL-60MCCB200-O
72	6	1296	CPL-72MCCB200-G	CPL-72MCCB200-O
84	6	1296	CPL-84MCCB200-G	CPL-84MCCB200-O
96	7	1512	CPL-96MCCB200-G	CPL-96MCCB200-O

Concept Plus Isolation chassis



GB chassis with busbar tee-offs that can be isolated prior to fitting or removal of MCB.
For more details see GB chassis.

No Main Switch

Pole Capacity	Module Size	Height (mm)	Catalogue No. Grey	Catalogue No. Orange
24	3	648	CPLG-24-G	CPLG-24-O
36	4	864	CPLG-36-G	CPLG-36-O
48	4	864	CPLG-48-G	CPLG-48-O
60	5	1080	CPLG-60-G	CPLG-60-O
72	6	1296	CPLG-72-G	CPLG-72-O
84	6	1296	CPLG-84-G	CPLG-84-O
96	7	1512	CPLG-96-G	CPLG-96-O

Concept Plus X-ROW



Extra row of DIN rail below chassis, able to fit extra 24 poles of DIN accessories

No Main Switch

Pole Capacity	Module Size	Height (mm)	Catalogue No. Grey	Catalogue No. Orange
30	4	864	CPLX-30-G	CPLX-30-O
48	5	1080	CPLX-48-G	CPLX-48-O
72	7	1512	CPLX-72-G	CPLX-72-O
96	8	1728	CPLX-96-G	CPLX-96-O

Width 600mm Depth 200mm includes door (20mm) excluding door handle

Concept Plus Energy metering panelboard



Single energy meter

- NABERS ready
- Monitors total panelboard consumption
- Energy meter EM270
- Single metering option
- Modbus RTU (serial)
- 2 x Pulse output

250A Main Switch

Pole Capacity	Module Size	Height (mm)	Catalogue No. Grey	Catalogue No. Orange
24	4	864	CPLMS-24-M250-G	CPLMS-24-M250-O
36	4	864	CPLMS-36-M250-G	CPLMS-36-M250-O
48	5	1080	CPLMS-48-M250-G	CPLMS-48-M250-O
60	6	1296	CPLMS-60-M250-G	CPLMS-60-M250-O
72	6	1296	CPLMS-72-M250-G	CPLMS-72-M250-O
84	7	1512	CPLMS-84-M250-G	CPLMS-84-M250-O
96	7	1512	CPLMS-96-M250-G	CPLMS-96-M250-O

Width 600mm Depth 200mm includes door (20mm) excluding door handle



Dual energy meter

- NABERS ready
- One energy meter that monitor light and power consumption separately
- Energy meter EM270
- Dual metering option
- Modbus RTU (serial)
- 2 x Pulse output

250A Main Switch

Total Pole Capacity	Pole Top	Pole Bottom	Module Size	Height (mm)	Catalogue No. Grey	Catalogue No. Orange
24	12	12	4	864	CPLMD-1212-M250-G	CPLMD-1212-M250-O
36	12	24	5	1080	CPLMD-1224-M250-G	CPLMD-1224-M250-O
36	18	18	5	1080	CPLMD-1818-M250-G	CPLMD-1818-M250-O
48	18	30	5	1080	CPLMD-1830-M250-G	CPLMD-1830-M250-O
48	24	24	5	1080	CPLMD-2424-M250-G	CPLMD-2424-M250-O
60	18	42	6	1296	CPLMD-1842-M250-G	CPLMD-1842-M250-O
60	30	30	6	1296	CPLMD-3030-M250-G	CPLMD-3030-M250-O
72	24	48	6	1296	CPLMD-2448-M250-G	CPLMD-2448-M250-O
72	36	36	7	1512	CPLMD-3636-M250-G	CPLMD-3636-M250-O
84	30	54	7	1512	CPLMD-3054-M250-G	CPLMD-3054-M250-O
84	42	42	7	1512	CPLMD-4242-M250-G	CPLMD-4242-M250-O
96	36	60	8	1728	CPLMD-3660-M250-G	CPLMD-3660-M250-O
96	48	48	8	1728	CPLMD-4848-M250-G	CPLMD-4848-M250-O

Width 600mm Depth 200mm includes door (20mm) excluding door handle

Concept Plus Accessory modules



Pole Capacity	Module Size	Height (mm)	Catalogue No. Grey	Catalogue No. Orange
---------------	-------------	-------------	--------------------	----------------------

DIN Cut-out

24	2	432	CPLACC-24-G	CPLACC-24-O
48	2	432	CPLACC-48-G	CPLACC-48-O
72	3	648	CPLACC-72-G	CPLACC-72-O

With-out Escutcheon

-	2	432	CPLACC-2M-G	CPLACC-2M-O
-	3	648	CPLACC-3M-G	CPLACC-3M-O

With Blank Escutcheon

-	2	432	CPLACC-2ME-G	CPLACC-2ME-O
-	3	648	CPLACC-3ME-G	CPLACC-3ME-O
-	4	864	CPLACC-4ME-G	CPLACC-4ME-O
-	5	1080	CPLACC-5ME-G	CPLACC-5ME-O
-	6	1296	CPLACC-6ME-G	CPLACC-6ME-O
-	7	1512	CPLACC-7ME-G	CPLACC-7ME-O
-	8	1728	CPLACC-8ME-G	CPLACC-8ME-O
-	9	1944	CPLACC-9ME-G	CPLACC-9ME-O

Gear Trays

Description	Module Size	Height (mm)	Catalogue No.
White gear tray	0.5	71	CELAGMS05
White gear tray	1	179	CELAGMS1
White gear tray	2	395	CELAGMS2
White gear tray	3	611	CELAGMS3

E/N KITS to Suit Accessory Modules

Description	Catalogue No.
24way 250A earth & neutral kit	CELEN24
36way 250A earth & neutral kit	CELEN36
48way 250A earth & neutral kit	CELEN48
60way 250A earth & neutral kit	CELEN60
72way 250A earth & neutral kit	CELEN72
84way 250A earth & neutral kit	CELEN84
96way 250A earth & neutral kit	CELEN96

Accessories

Description	Catalogue No.
Top mullion plate	CELAMMS
Segregation barrier Aluminum 2mm	CPLASBAL2

Concept Plus Accessories



Description	Catalogue No.
Main-Switch Kits	
Isolator switch kit 160A 3P	CEL3160
Isolator switch kit 250A 3P	CEL3250
MCCB S160NJ main switch kit 3P-NC (Adjustable 100-160A)	CELMCCB3160
MCCB S250NJ main switch kit 3P-NC (Adjustable 160-200A)	CELMCCB3200
MCCB S160NJ main switch kit 3P-GB (Adjustable 100-160A)	CELMCCB3160GB
MCCB S250NJ main switch kit 3P-GB (Adjustable 160-200A)	CELMCCB3200GB
General Accessories	
IP52 kit	CPEIP52M*
Emergency lighting test kit rotary switch (pre wired)	CPELK1W
Emergency lighting test kit key switch	CPELK2
External light control kit on-off-auto 1CH 2N/O 25A	CELEXTLKC
External light control kit on-off-auto 1CH 2N/O 25A	CELEXTLK1
External light control kit on-off-auto 2CH 2N/O 25A	CELEXTLK2
Surge kit 40KA MCB + surge type 2 + loom	CELSURGEK1
Safety service mechanical separation kit 1P	CELASSED1
Safety service mechanical separation kit 2P	CELASSED2
Safety service mechanical separation kit 3P	CELASSED3
Wall mounting kit black	CELABGBBK
7mm deep schedule card holder	CELACMSA4
Door hinge reversal kit (RH to LH)	CELAKDHR
Gland Plates	
Steel 1.6mm grey	CPELGPM51SG
Steel 1.6mm orange	CPELGPM51OR
Aluminium 3mm	CPELGPAL3
Bakelite 5mm	CPELGPBK5
Brass 3mm	CPELGPBR3
Gasket	CPELGGF
Door Handles	
Door swing handle CL001	CELHDSPSC
Door swing handle 92268	CELHDSPS9
Door swing handle padlockable	CELHDSPPP
Door swing handle E-Key "Pwd"	CELHDSPBE
Door swing handle non lockable	CELHDSZNKIT
Door swing handle 7mm square	CELHDSZQ7KIT
Door handle cam roller - three point	CELHCRP21C60
Door handle cam roller - single point	CELHCRP21A60

* Insert module size, e.g. CPEIP52M4 for 4 module

Concept Plus Accessories



Flush Mounting Kit

Module Size	Height (mm)	Catalogue No. Grey	Catalogue No. Orange
2	432	CELAFK-2-SG	CELAFK-2-OR
3	648	CELAFK-3-SG	CELAFK-3-OR
4	864	CELAFK-4-SG	CELAFK-4-OR
5	1080	CELAFK-5-SG	CELAFK-5-OR
6	1296	CELAFK-6-SG	CELAFK-6-OR
7	1512	CELAFK-7-SG	CELAFK-7-OR
8	1728	CELAFK-8-SG	CELAFK-8-OR
9	1944	CELAFK-9-SG	CELAFK-9-OR

Plinth

Description	Catalogue No.
Plinth single 75mm hot dipped gal	CPLAP-S-GAL
Plinth double 75mm hot dipped gal	CPLAP-D-GAL
Plinth triple 75mm hot dipped gal	CPLAP-T-GAL

Escutcheons Labels

Description	Catalogue No.
DIN 1-48 way (18mm pitch)	LABLEG148D
DIN 49-96 way (18mm pitch)	LABLEG4996D
DIN 97-144 way (18mm pitch)	390.00007
DIN 1-24 way (27mm pitch)	390.00006

Locking Rods

Locking rod to suit 3M 648mm	CELDLR3MS
Locking rod to suit 4M 864mm	CELDLR4MS
Locking rod to suit 5M 1080mm	CELDLR5MS
Locking rod to suit 6M 1296mm	CELDLR6MS
Locking rod to suit 7M 1512mm	CELDLR7MS
Locking rod to suit 8M 1728mm	CELDLR8MS
Locking rod to suit 9M 1944mm	CELDLR9MS

Concept Premier

The premium panelboard - for DIN-T MCB and MCCB

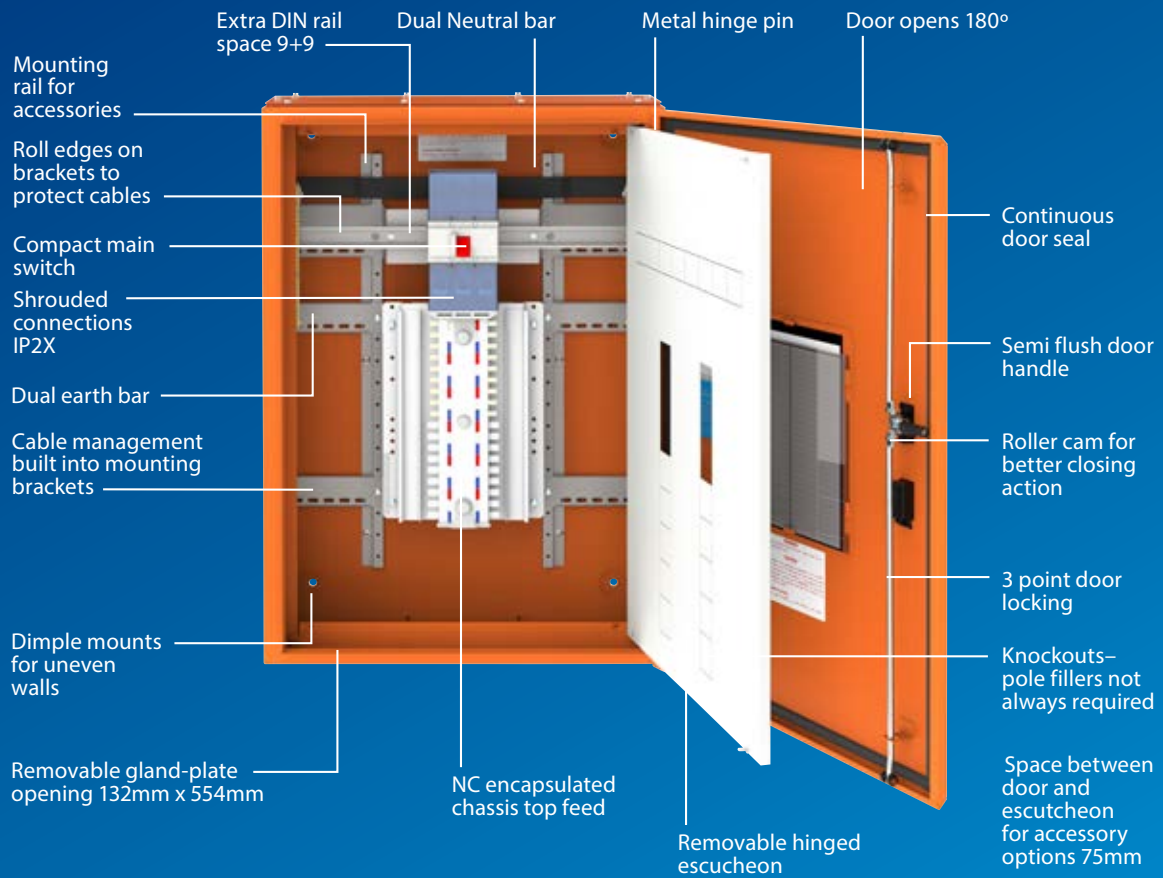

Concept Premier



The premium panelboard - for DIN-T MCB & MCCB

Commercial and industrial applications

- IP66 rating
- Grey or Orange colour options in mild steel
- Orange or natural finish in stainless steel
- 1.6mm fully welded construction
- Gloss white removable hinged escutcheon that is independent from the door
- Knockouts in the escutcheon for up to 18 modules of extra DIN rail equipment
- 8 modular sizes cover the range from 24-96pole (432mm-1944mm)
- Door hinged right-hand side
- Semi flush door swing handle with various door locking options
- Compact main-switch options 160A or 250A isolator or 100-200A MCCB
- Earth and Neutral bars, circuit identification and schedule cards included as standard
- Dual earth / neutral bars
- Semi concealed door hinges



Material type 1.6mm Steel enclosure
1.0 / 1.2mm Steel escutcheon

Finish Textured polyester powder coated

Colour Enclosure – Grey (N42 storm grey)
Enclosure – Orange (X15)
Escutcheon – Bright White gloss

Protection Degree IP30 without door
IP66 with door

Busbar ratings Current Rating 250A (option 400A)
NC 250A I_{cw} 25kA 0.1s 20kA 0.3s & 10kA 1.0s
NC 400A I_{cw} 30kA 0.1s, 25kA 0.3s
GB 250A I_{cw} 25kA 0.1s & 10kA 1.0s

Neutral & Earth Bar (up to 250A DBs) Current rating 250A
M8 stud top and bottom
Spare 1x16mm² & 1x25mm² tunnels
QTY 2 x 25mm² tunnels
Balance 16mm² tunnels
Tunnels 2 screw

Main Switch Isolator 160A
Isolator 250A
MCCB S160NJ (100-160A)
MCCB S250NJ (160-200A)



Concept Premier

Standard panelboard - CPR

NC 250A busbar chassis top feed 3P

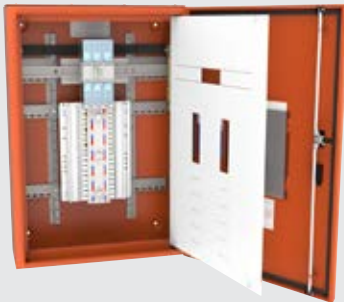

MCCB panelboard*

MCCB chassis busbar chassis suits Terasaki MCCBs

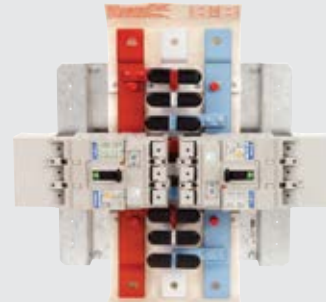

Isolation chassis panelboard*

Isolation chassis GB 250A busbar chassis top feed 3P, Busbar tee-off can be isolated prior to fitting or removing MCB
Captive locking mechanism option



400A MCB chassis*

400A MCB chassis no main-switch, isolator or circuit breaker
MCCB main-switch options.



Captive locking panelboard LOCKDIN*

Escutcheon cut-out suitable for MCB captive locking system "LOCKDIN"



For other options contact NHP

- 800A MCCB chassis suit 250AF MCCBs
- Hybrid chassis for MCCB to suit 125AF, 160AF and 250AF MCCBs
- Single sided MCCB chassis options
- Hybrid chassis suits 80-125A MCBs and 0.5-63A MCBs
- Surge protection
- Emergency lighting control

CPR panelboards are available in either grey, orange, orange stainless steel or natural stainless steel options.

CPR panelboards can be fitted with 160A or 250A isolator main switch or 160A or 200A MCCB main switch.**

*Made to order contact NHP

**Excludes MCCB chassis panelboards

Concept Premier Panelboards



Pole Capacity	Module Size	Height (mm)	Catalogue No. Grey	Catalogue No. Orange
---------------	-------------	-------------	--------------------	----------------------

No Main Switch

24	3	648	CPR-24-G	CPR-24-O
36	4	864	CPR-36-G	CPR-36-O
48	4	864	CPR-48-G	CPR-48-O
60	5	1080	CPR-60-G	CPR-60-O
72	6	1296	CPR-72-G	CPR-72-O
84	6	1296	CPR-84-G	CPR-84-O
96	7	1512	CPR-96-G	CPR-96-O

160A Main Switch

24	3	648	CPR-24M160-G	CPR-24M160-O
36	4	864	CPR-36M160-G	CPR-36M160-O
48	4	864	CPR-48M160-G	CPR-48M160-O
60	5	1080	CPR-60M160-G	CPR-60M160-O

250A Main Switch

24	3	648	CPR-24M250-G	CPR-24M250-O
36	4	864	CPR-36M250-G	CPR-36M250-O
48	4	864	CPR-48M250-G	CPR-48M250-O
60	5	1080	CPR-60M250-G	CPR-60M250-O
72	6	1296	CPR-72M250-G	CPR-72M250-O
84	6	1296	CPR-84M250-G	CPR-84M250-O
96	7	1512	CPR-96M250-G	CPR-96M250-O

160A Main Switch (MCCB Adjustable 100-160A)

24	3	648	CPR-24MCCB160-G	CPR-24MCCB160-O
36	4	864	CPR-36MCCB160-G	CPR-36MCCB160-O
48	4	864	CPR-48MCCB160-G	CPR-48MCCB160-O
60	5	1080	CPR-60MCCB160-G	CPR-60MCCB160-O
72	6	1296	CPR-72MCCB160-G	CPR-72MCCB160-O
84	6	1296	CPR-84MCCB160-G	CPR-84MCCB160-O
96	7	1512	CPR-96MCCB160-G	CPR-96MCCB160-O

200A Main-Switch (MCCB Adjustable 160-200A)

24	3	648	CPR-24MCCB200-G	CPR-24MCCB200-O
36	4	864	CPR-36MCCB200-G	CPR-36MCCB200-O
48	4	864	CPR-48MCCB200-G	CPR-48MCCB200-O
60	5	1080	CPR-60MCCB200-G	CPR-60MCCB200-O
72	6	1296	CPR-72MCCB200-G	CPR-72MCCB200-O
84	6	1296	CPR-84MCCB200-G	CPR-84MCCB200-O
96	7	1512	CPR-96MCCB200-G	CPR-96MCCB200-O

Width 600mm Depth 240mm includes door (20mm) excluding door handle

Concept Premier Accessory modules



Pole Capacity	Module Size	Height (mm)	Catalogue No. Grey	Catalogue No. Orange
DIN Cut-out				
24	2	432	CPRACC-24-G	CPRACC-24-O
48	2	432	CPRACC-48-G	CPRACC-48-O
72	3	648	CPRACC-72-G	CPRACC-72-O
Without Escutcheon				
-	2	432	CPRACC-2M-G	CPRACC-2M-O
-	3	648	CPRACC-3M-G	CPRACC-3M-O
With Blank Escutcheon				
-	2	432	CPRACC-2ME-G	CPRACC-2ME-O
-	3	648	CPRACC-3ME-G	CPRACC-3ME-O
-	4	864	CPRACC-4ME-G	CPRACC-4ME-O
-	5	1080	CPRACC-5ME-G	CPRACC-5ME-O
-	6	1296	CPRACC-6ME-G	CPRACC-6ME-O
-	7	1512	CPRACC-7ME-G	CPRACC-7ME-O
-	8	1728	CPRACC-8ME-G	CPRACC-8ME-O
-	9	1944	CPRACC-9ME-G	CPRACC-9ME-O

Width 600mm Depth 240mm includes door (20mm) excluding door handle

Description	Modules Size	Height (mm)	Catalogue No.
Gear Trays			
White gear tray	0.5	71	CELAGMS05
White gear tray	1	179	CELAGMS1
White gear tray	2	395	CELAGMS2
White gear tray	3	611	CELAGMS3

Description	Catalogue No.
E/N KITS to Suit Accessory Modules	
24way 250A earth & neutral kit	CELEN24
36way 250A earth & neutral kit	CELEN36
48way 250A earth & neutral kit	CELEN48
60way 250A earth & neutral kit	CELEN60
72way 250A earth & neutral kit	CELEN72
84way 250A earth & neutral kit	CELEN84
96way 250A earth & neutral kit	CELEN96
Accessories	
Top mullion plate	CELAMMS
Segregation barrier Aluminum 2mm	CPRASBAL2

Concept Premier Accessories



Description	Catalogue No.
Main-Switch Kits	
Isolator switch kit 160A 3P	CEL3160
Isolator switch kit 250A 3P	CEL3250
MCCB S160NJ main switch kit 3P- NC (Adjustable 100-160A)	CELMCCB3160
MCCB S250NJ main switch kit 3P- NC (Adjustable 160-200A)	CELMCCB3200
MCCB S160NJ main switch kit 3P- GB (Adjustable 100-160A)	CELMCCB3160GB
MCCB S250NJ main switch kit 3P- GB (Adjustable 160-200A)	CELMCCB3200GB
General Accessories	
Emergency lighting test kit rotary switch (pre wired)	CPELK1W
Emergency lighting test kit key switch	CPELK2
External light control kit on-off-auto 1CH 2N/O 25A	CELEXTLKC
External light control kit on-off-auto 1CH 2N/O 25A	CELEXTLK1
External light control kit on-off-auto 2CH 4N/O 25A	CELEXTLK2
Surge Kit 40kA MCB + surge type 2 + loom	CELSURGEK1
Safety service mechanical separation kit 1P	CELASSED1
Safety service mechanical separation kit 2P	CELASSED2
Safety service mechanical separation kit 3P	CELASSED3
Wall mounting kit black	CELABGBBK
IP66 mounting sealing kit	CPPIP66
7mm deep schedule card holder	CELACMSA4
Door hinge reversal kit (RH to LH)	CELAKDHR
Gland Plates	
Steel 2.0mm grey	CPREGPMS2SG
Steel 2.0mm orange	CPREGPMS2OR
Aluminium 3mm	CPREGPAL3
Aluminium 6mm	CPREGPAL6
Bakealite 5mm	CPREGPBK5
Brass 3mm	CPREGPBR3
Gasket	CPREGGF
Door Handles	
Door swing handle IP66 CL001	CELHDSZSC
Door swing handle IP66 92268	CELHDSZS9
Door swing handle IP66 padlockable	CELHDSZPP
Door swing handle IP66 E-Key "Pwd"	CELHDSZBE
Door swing handle IP66 non lockable	CELHDSZNKIT
Door swing handle IP66 7mm square	CELHDSZQ7KIT
Door handle cam roller - three point	CELHCRP21C60

Concept Premier Accessories

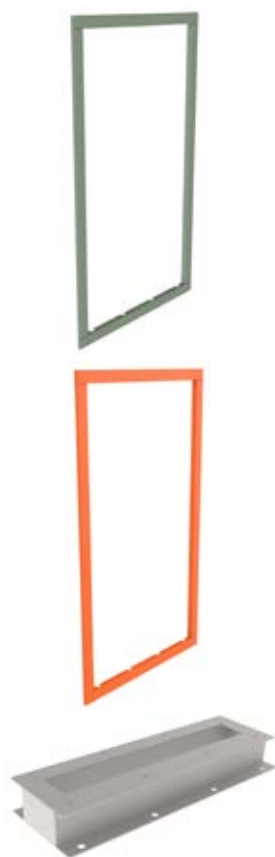

1	2
3	4
5	6
7	8
9	10
11	12
13	14
15	16
17	18
19	20
21	22
23	24
25	26
27	28
29	30
31	32
33	34
35	36
37	38
39	40
41	42
43	44
45	46
47	48

Module Size	Height (mm)	Catalogue No. Grey	Catalogue No. Orange
-------------	-------------	--------------------	----------------------

Flush Mounting Kit

2	432	CELFK-2-SG	CELFK-2-OR
3	648	CELFK-3-SG	CELFK-3-OR
4	864	CELFK-4-SG	CELFK-4-OR
5	1080	CELFK-5-SG	CELFK-5-OR
6	1296	CELFK-6-SG	CELFK-6-OR
7	1512	CELFK-7-SG	CELFK-7-OR
8	1728	CELFK-8-SG	CELFK-8-OR
9	1944	CELFK-9-SG	CELFK-9-OR

Rainhood

Single 75mm	CPRAR-S-SG	CPRAR-S-OR
Double 75mm	CPRAR-D-SG	CPRAR-D-OR
Triple 75mm	CPRAR-T-SG	CPRAR-T-OR

Plinth

Single 75mm hot dipped gal	CPRAP-S-GAL
Double 75mm hot dipped gal	CPRAP-D-GAL
Triple 75mm hot dipped gal	CPRAP-T-GAL

Description	Catalogue No.
-------------	---------------

Escutcheon Labels

DIN 1-48 way (18mm Pitch)	LABLEG148D
DIN 49-96 way (18mm Pitch)	LABLEG4996D
DIN 97-144 way (18mm Pitch)	390.00007
DIN 1-24 way (27mm Pitch)	390.00006

Locking Rods

Locking rod to suit 3M 648mm	CELDLR3MS
Locking rod to suit 4M 864mm	CELDLR4MS
Locking rod to suit 5M 1080mm	CELDLR5MS
Locking rod to suit 6M 1296mm	CELDLR6MS
Locking rod to suit 7M 1512mm	CELDLR7MS
Locking rod to suit 8M 1728mm	CELDLR8MS
Locking rod to suit 9M 1944mm	CELDLR9MS

Concept Premier Stainless steel panelboards



Pole Capacity	Module Size	Height (mm)	Catalogue No. Orange	Catalogue No. Natural
No Main Switch				
24	3	648	CPR-24-SSO	CPR-24-SS
36	4	864	CPR-36-SSO	CPR-36-SS
48	4	864	CPR-48-SSO	CPR-48-SS
60	5	1080	CPR-60-SSO	CPR-60-SS
72	6	1296	CPR-72-SSO	CPR-72-SS
84	6	1296	CPR-84-SSO	CPR-84-SS
96	7	1512	CPR-96-SSO	CPR-96-SS

Width 600mm Depth 240mm includes door (20mm) excluding door handle



Concept Premier Stainless steel accessory modules



Pole Capacity	Module Size	Height (mm)	Catalogue No. Orange	Catalogue No. Natural
DIN Cut-out				
24	2	432	CPRACC-24-SSO	CPRACC-24-SS
48	2	432	CPRACC-48-SSO	CPRACC-48-SS
72	3	648	CPRACC-72-SSO	CPRACC-72-SS
With-out Escutcheon				
-	2	432	CPRACC-2M-SSO	CPRACC-2M-SS
-	3	648	CPRACC-3M-SSO	CPRACC-3M-SS
With Blank Escutcheon				
-	2	432	CPRACC-2ME-SSO	CPRACC-2ME-SS
-	3	648	CPRACC-3ME-SSO	CPRACC-3ME-SS
-	4	864	CPRACC-4ME-SSO	CPRACC-4ME-SS
-	5	1080	CPRACC-5ME-SSO	CPRACC-5ME-SS
-	6	1296	CPRACC-6ME-SSO	CPRACC-6ME-SS
-	7	1512	CPRACC-7ME-SSO	CPRACC-7ME-SS
-	8	1728	CPRACC-8ME-SSO	CPRACC-8ME-SS
-	9	1944	CPRACC-9ME-SSO	CPRACC-9ME-SS
Width 600mm Depth 240mm includes door (20mm) excluding door handle				

Description	Module size	Height (mm)	Catalogue No.
Gear Trays			
White gear tray	0.5	71	CELAGMS05
White gear tray	1	179	CELAGMS1
White gear tray	2	395	CELAGMS2
White gear tray	3	611	CELAGMS3

Description	Catalogue No.
E/N KITS to Suit Accessory Modules	
24way 250A earth & neutral kit	CELEN24
36way 250A earth & neutral kit	CELEN36
48way 250A earth & neutral kit	CELEN48
60way 250A earth & neutral kit	CELEN60
72way 250A earth & neutral kit	CELEN72
84way 250A earth & neutral kit	CELEN84
96way 250A earth & neutral kit	CELEN96
Accessories	
Top mullion plate	CELAMMS
Segregation barrier Aluminum 2mm	CPRASBAL2

Concept Premier Stainless steel accessories



Description	Catalogue No.
-------------	---------------

Main Switch Kits

Isolator switch kit 160A 3P	CEL3160
Isolator switch kit 250A 3P	CEL3250
MCCB S160NJ main switch kit 3P- NC (Adjustable 100-160A)	CELMCCB3160
MCCB S250NJ main switch kit 3P- NC (Adjustable 160-200A)	CELMCCB3200
MCCB S160NJ main switch kit 3P- GB (Adjustable 100-160A)	CELMCCB3160GB
MCCB S250NJ main switch kit 3P- GB (Adjustable 160-200A)	CELMCCB3200GB

Gland Plates

Aluminium 3mm	CPREGPAL3
Aluminium 6mm	CPREGPAL6
Bakelite 5mm	CPLEGPBK5
Brass 3mm	CPREGPBR3
Stainless steel 2mm	CPREGPSS211
Stainless steel orange 2mm	CPREGPSSO211
Gasket	CPREGGF

Door Handles

Door swing handle SS IP66 CL001	CELHDSSSC
Door swing handle SS IP66 92268	CELHDSSS9
Door swing handle SS IP66 padlockable	CELHDSSPP
Door swing handle SS IP66 E-key "pwd"	CELHDSSBE
Door swing handle SS IP66 non lockable	CELHDSSNKIT
Door handle cam roller	CELHCRP21C60

Description	Catalogue No. Orange	Catalogue No. Natural
-------------	----------------------	-----------------------

Plinth

Single 75mm 316 s/steel	CPRAP-S-SSO	CPRAP-S-SS
Double 75mm 316 s/steel	CPRAP-D-SSO	CPRAP-D-SS
Triple 75mm 316 S/Steel	CPRAP-T-SSO	CPRAP-T-SS

Rainhood

Single 316 s/steel	CPRAR-S-SSO	CPRAR-S-SS
Double 316 s/steel	CPRAR-D-SSO	CPRAR-D-SS
Triple 316 s/steel	CPRAR-T-SSO	CPRAR-T-SS

General

Wall mounting kit S/Steel		CELABSS11
---------------------------	--	-----------

Concept Tough

The heavy duty panelboard for DIN-T MCB and MCCB

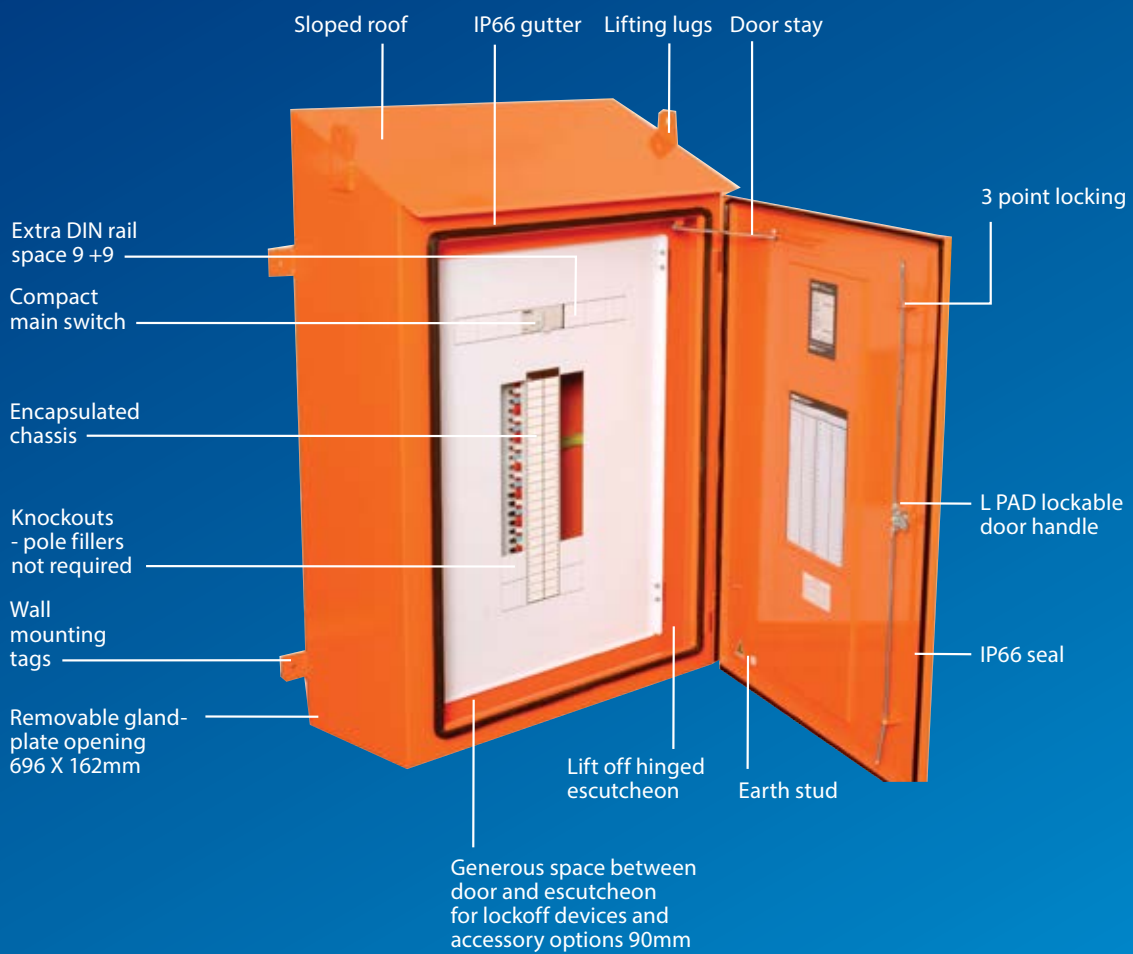

Concept Tough



The heavy duty panelboard for DIN-T MCB and MCCB

Commercial and industrial applications

- IP66 rating
- 2mm fully welded construction
- Available in stainless or mild steel construction
- Gloss white lift-off hinged escutcheon that is independent from the door
- Generous depth between door and escutcheon allow wide range lock-off devices
- Knockouts in the escutcheon for up to 18 modules of extra DIN rail equipment
- 4 modular sizes cover the range from 24-96 pole (500mm-2000mm)
- Door hinged right-hand side
- Pad lockable semi flush door swing handle
- Large gland plates to allow for incoming/outgoing cables
- Compact 250A main-switch
- Mount up to a CA 6-420 contactor behind the escutcheon
- Earth and Neutral bar, circuit identification and schedule cards as standard
- Dual Earth / neutral bars
- Semi concealed door hinges
- Available in stainless or mild steel construction

Material type	2.0mm Steel 1.6mm Escutcheon
Finish	Polyester powder coated (mild steel version)
Colour	Enclosure – Orange (X15) Escutcheon – Bright White gloss
Protection Degree	IP30 without door IP66 with door
Busbar ratings	Current Rating 250A NC 250A I_{cw} 25kA 0.1s, 20kA 0.3s & 10kA 1.0s
Neutral & Earth Bar	Current rating 250A 2 x M8 studs QTY 2 x 25mm ² tunnels Balance 16mm ² tunnels Tunnels 2 screw
Main Switch	Isolator 250A

Concept Tough Pole capacity and dimensions



Suits Din-T applications (Concept Tough)

Pole C apacity	Box Size	Height	Catalogue No.
18	Size 2	1000	CTD180
24	Size 2	1000	CTD240
36	Size 2	1000	CTD360
48	Size 2	1000	CTD480
60	Size 3	1500	CTD600
72	Size 3	1500	CTD720
84	Size 3	1500	CTD840
96	Size 3	1500	CTD960

Suits MCCB applications (Concept Tough)

18	Size 2	1000	CTX180
24	Size 2	1000	CTX240
36	Size 3	1500	CTX360
48	Size 3	1500	CTX480
60	Size 3	1500	CTX600
72	Size 4	2000	CTX720

Width = 800mm Depth = 324mm includes door = 20mm excluding door handle

Notes:

- CTX panelboards are fully assembled from stocked components.
- If a larger isolator is required, an increase in box size may be required.
- If stainless steel is required, replace the "O" in the above Cat. No. with "SS".

DIN cut-out



Pole Capacity STD Din	Pole Capacity Lockdin	Height (mm)	Catalogue No. Orange
-	0	500	CTACCO
3	21	500	CTACC24HO
24	0	500	CTACC24O

NHP Power HUB



Health Dashboard

MV Switchgear

LV Switchboard

2MVA Transformer

MV RMU

MV Kiosk with Arc Killer

The NHP Power Hub is a purpose built, specialist demonstration and training facility located at the NHP head office in Melbourne Victoria. The Power Hub showcases NHP's full power distribution portfolio, from medium voltage to low voltage solutions, including NHP's new generation 3 Concept panelboards.

The high quality medium to low voltage solutions on display are fully interactive and are fitted out to replicate a typical site installation. These displays have advanced features that facilitate hands on demonstration, not only delivering specialist knowledge and training, but instilling product confidence for those who visit the facility.

Specialist products on display include a full range of medium voltage equipment including DF2 de-mountable switchgear with a variety of functional panels, withdrawable switchgear, ring main units, oil immersed and cast resin transformers, Agile protection relays and a 2MVA kiosk substation.

Exclusive to NHP's medium voltage solutions is the DF2+ air insulated modular type switchgear which features a built-in arc quenching system called 'Arc Killer' which can extinguish an arc in less than 50ms. 1300 NHP or contact your NHP sales representative to arrange a tour of the PowerHub.

Concept accessories

NHP		
LIST OF MAIN SWITCH NO.		
FED FROM	MAIN EARTH LOCATED AT	
1		2
2		4
3		4
4		4
5		4
6		4
7		4
8		4
9		4
10		4
11		12
12		12
13		14
14		14
15		14
16		14
17		14
18		20
19		20
20		20
21		24
22		24
23		28
24		28
25		28
26		32
27		32
28		32
29		32
30		32
31		32
32		32
33		32
34		32
35		32
36		32
37		32
38		40
39		42
40		44
41		44
42		44
43		44
44		44
45		44
46		44
47		44
48		44
49		44
50		44
51		44
52		44
53		44
54		44
55		44
56		44
57		44
58		44
59		44



MAIN SWITCH	MAIN ISOLATOR	ISOLATOR
IN THE CASE OF AN EMERGENCY SWITCH TO OFF	240/415V AC LIGHT & POWER	Prospective Fault Level at Switchboard In
POWER	MAIN ISOLATOR LIGHT	MAIN ISOLATOR
POWER	MAIN SWITCH HOT WATER	MAIN SWITCH
POWER	HOT WATER	DO NOT TURN OFF
POWER	BYPASS SWITCH	ENERGY METER
POWER	OFF PEAK SWITCH	PROTECTED POWER
POWER	SURGE PROTECTION	PROTECTED POWER
POWER	240V AC LIGHT	PROTECTED LIGHT
POWER	240V AC POWER	PROTECTED LIGHT
LIGHT	SECURITY LIGHTING	GARDEN LIGHTS
LIGHT	SECURITY LIGHTING	GARDEN LIGHTS
LIGHT	EXTERNAL LIGHTING	FLOOD LIGHTS
LIGHT	EXTERNAL LIGHTING	FLOOD LIGHTS
LIGHT	240/415V AC LIGHT	SURGE PROTECTION
LIGHT	240/415V AC POWER	AIR CONDITIONER
LIGHT	240V AC LIGHT & POWER	AIR CONDITIONER
LIGHT	415V AC LIGHT & POWER	AIR CONDITIONER
BYPASS SWITCH	EARTH LEAKAGE CIRCUIT BREAKER	EARTH LEAKAGE CIRCUIT BREAKER
		OFF PEAK SWITCH
		PROTECTED NEUTRAL

Concept Accessories

MAIN SWITCH		MAIN ISOLATOR		ISOLATOR	
BY THE CARE OF THE REFERENCED SUPPLY		240/415V AC LIGHT & POWER		Prospective Fault level at Switchboard 42	
POWER	MAIN ISOLATOR LIGHT	MAIN ISOLATOR	SERVER	AUTO	
POWER	MAIN ISOLATOR LIGHT	MAIN ISOLATOR	SERVER	OFF	
POWER	MAIN SWITCH HOT WATER	MAIN SWITCH	ALARM	MANUAL	
POWER	HOT WATER	DO NOT TURN OFF	SUB BOARD		
POWER	BYPASS SWITCH	ENERGY METER	TIME SWITCH	CEILING FAN	
POWER	OFF PEAK SWITCH	PROTECTED POWER	TIME SWITCH	CEILING FAN	
POWER	SURGE PROTECTION	PROTECTED LIGHT	DISH WASHER	CEILING FAN	
POWER	240V AC LIGHT	PROTECTED LIGHT	TOWEL RACK	SAUNA	
POWER	240V AC POWER	PROTECTED LIGHT	SPK	STOVE	
LIGHT	SECURITY LIGHTING	GARDEN LIGHTS	POOL	FRIDGE	
LIGHT	SECURITY LIGHTING	GARDEN LIGHTS	PUMP	FREEZER	
LIGHT	EXTERNAL LIGHTING	FLOOD LIGHTS	BYPASS	OVEN	
LIGHT	EXTERNAL LIGHTING	FLOOD LIGHTS	HOT PLATES	OVEN	
LIGHT	240/415V AC LIGHT	SURGE PROTECTION	HOT PLATES	LAUNDRY	
LIGHT	240/415V AC POWER	AIR CONDITIONER	TEST BENCH	COMPUTER	
LIGHT	240V AC LIGHT & POWER	AIR CONDITIONER	GARAGE	COMPUTER	
LIGHT	415V AC LIGHT & POWER	AIR CONDITIONER	WORKSHOP	COMPUTER	
BYPASS SWITCH	EARTH LEAKAGE CIRCUIT BREAKER	EARTH LEAKAGE CIRCUIT BREAKER	OFF PEAK SWITCH	PROTECTED NEUTRAL	



Description	Catalogue No.
General	
Door A4 schedule card	CPSCHEDULECARD
Door sticker set A4	LBLPWBKACC
Door schedule card holder clear sheet A4	CELACPA4
Door schedule card holder 7mm pocket A4 white	CELACMSA4
Pole fillers (4 poles)	DTPF
Spare key CL001	KEYCL001
Spare key 92268	KEY92268
Escutcheon numbering 1-48	LABLEG148D
Escutcheon numbering 49-96	LABLEG4996D
Chassis mount DIN isolator 100A 1P to remotely feed DINT10H	DINTMS1001
Chassis mount DIN isolator 100A 3P to remotely feed DINT10H	DINTMS1003
Chassis mount DIN through terminal 100A 1P to remotely feed DINT10H	DINTT100A
Neutral bar support	CELSNM517
Neutral bar strap CPL	CPLBSNC
Neutral bar strap CPL	CPRBSNC
Escutcheon screw	FXSM5TX10HD12Z
Ducting support	CELSU
Neutral extension bar 250A	CELBECB4
Neutral bar side connection tag 250A	CELBTC1CC
Neutral bar side connection tag 400A	CELBTG1CC
Touch up paint	
Storm grey N42	CELATPSG
X15 orange	CELATPOR
Bright white	CELATPWH
Light grey RAL7035	CELATPLG
Connection kits (includes spacer/tag & shrouds)	
NC chassis to MCCB 160/250 direct with spacers TF/BF 3P	NCKK3200
GB chassis to MCCB 160/250 direct with spacers TF/BF 3P	GBCK3200
NC chassis to MCCB 160/250 tag connect TF/BF 3P*	NCKK3250
NC chassis to VLB 250 tag connect TF/BF 3P*	NCKK3250VLB
NC chassis to VLB 400 tag connect TF/BF 3P*	NCKK3400VLB
Connection kits (includes supports, tags & shrouds)*	
Concept Plus NC chassis to VLB 250A TF/BF 3P	CPLNCKK3250VLB
Concept Plus NC chassis to VLB 400A TF/BF 3P	CPLNCKK3400VLB
Concept Plus NC to MCCB 160/250 TF/BF 3P	CPLMCCB3250
Concept Premier NC chassis to VLB 250A TF/BF 3P	CPRNCKK3250VLB
Concept Premier NC chassis to VLB 400A TF/BF 3P	CPRNCKK3400VLB
Concept Premier NC to MCCB 160/250 TF/BF 3P	CPRMCCB3250

*Factory fitted

Concept Accessories



Description	Catalogue No.	
Earth and Neutral bars		
E/N Bar 250A 24 way 2 screw 1-24	CELBNC-24-A2	
E/N Bar 250A 30 way 2 screw 1-30	CELBNC-30-A2	
E/N Bar 250A 36 way 2 screw 1-36	CELBNC-36-A2	
E/N Bar 250A 42 way 2 screw 1-42	CELBNC-42-A2	
E/N Bar 250A 48 way 2 screw 1-48	CELBNC-48-A2	
E/N Bar 250A 60 way 2 screw 1-60	CELBNC-60-A2	
E/N Bar 250A 72 way 2 screw 1-72	CELBNC-72-A2	
E/N Bar 250A 84 way 2 screw 1-84	CELBNC-84-A2	
E/N Bar 250A 96 way 2 screw 1-96	CELBNC-96-A2	
E/N Bar 400A 12 way 2 screw 1-12	CELBNG-12-A2	
E/N Bar 400A 18 way 2 screw 1-18	CELBNG-18-A2	
E/N Bar 400A 24 way 2 screw 1-24	CELBNG-24-A2	
E/N Bar 400A 30 way 2 screw 1-30	CELBNG-30-A2	
E/N Bar 400A 36 way 2 screw 1-36	CELBNG-36-A2	
E/N Bar 400A 42 way 2 screw 1-42	CELBNG-42-A2	
E/N Bar 400A 48 way 2 screw 1-48	CELBNG-48-A2	
E/N Bar 400A 60 way 2 screw 1-60	CELBNG-60-A2	
E/N Bar 400A 72 way 2 screw 1-72	CELBNG-72-A2	
E/N Bar 400A 84 way 2 screw 1-84	CELBNG-84-A2	
E/N Bar 400A 96 way 2 screw 1-96	CELBNG-96-A2	

Description	Catalogue No. Odd No.	Catalogue No. Even No.
Earth and Neutral bars		
E/N Bar 250A 12 way 2 screw 1-24	CELBNC-12-C2	CELBNC-12-B2
E/N Bar 250A 18 way 2 screw 1-36	CELBNC-18-C2	CELBNC-18-B2
E/N Bar 250A 24 way 2 screw 1-48	CELBNC-24-C2	CELBNC-24-B2
E/N Bar 250A 30 way 2 screw 1-60	CELBNC-30-C2	CELBNC-30-B2
E/N Bar 250A 36 way 2 screw 1-72	CELBNC-36-C2	CELBNC-36-B2
E/N Bar 250A 42 way 2 screw 1-84	CELBNC-42-C2	CELBNC-42-B2
E/N Bar 250A 48 way 2 screw 1-96	CELBNC-48-C2	CELBNC-48-B2
E/N Bar 400A 12 way 2 screw 1-24	CELBNG-12-C2	CELBNG-12-B2
E/N Bar 400A 18 way 2 screw 1-36	CELBNG-18-C2	CELBNG-18-B2
E/N Bar 400A 24 way 2 screw 1-48	CELBNG-24-C2	CELBNG-24-B2
E/N Bar 400A 30 way 2 screw 1-60	CELBNG-30-C2	CELBNG-30-B2
E/N Bar 400A 36 way 2 screw 1-72	CELBNG-36-C2	CELBNG-36-B2
E/N Bar 400A 42 way 2 screw 1-84	CELBNG-42-C2	CELBNG-42-B2
E/N Bar 400A 48 way 2 screw 1-96	CELBNG-48-C2	CELBNG-48-B2

Concept Busbar chassis



NC chassis

- Standard AS/NZ3439.1
- Current ratings 250A, 400A
- NC - 250A 25kA 0.1S

- NC - 400A 30kA 0.1S
- Full encapsulated chassis
- Tee-offs 50% capped

NC chassis - top feed

Pole Capacity	Catalogue No. 250A	Catalogue No. 400A
24way 3Pole	NC2-2418-3TF	NC4-2418-3TF
36way 3Pole	NC2-3618-3TF	NC4-3618-3TF
48way 3Pole	NC2-4818-3TF	NC4-4818-3TF
60way 3Pole	NC2-6018-3TF	NC4-6018-3TF
72way 3Pole	NC2-7218-3TF	NC4-7218-3TF
84way 3Pole	NC2-8418-3TF	NC4-8418-3TF
96way 3Pole	NC2-9618-3TF	NC4-9618-3TF

Pole Capacity	Catalogue No.
Tee-off cap 18mm	NC250TOPC
Tee-off cap 27mm	NC250HTOPC
Tee-off cap 18mm (400A)	NC400TOPC
Tee-off cap 27mm (400A)	NC400HTOPC
Busbar cap	NCBBC



GB isolation chassis

- Standard AS/NZ3439.1
- Current ratings 250A
- NC - 250A 25kA 0.1S
- Full encapsulated chassis

- Colour coded isolation switch per tee-off
- Mechanical interlock
- Tee-offs 50% capped

GB chassis - top feed

Pole Capacity	Catalogue No. 400A
24way 3Pole	GB2-2418-3TF
36way 3Pole	GB2-3618-3TF
48way 3Pole	GB2-4818-3TF
60way 3Pole	GB2-6018-3TF
72way 3Pole	GB2-7218-3TF
84way 3Pole	GB2-8418-3TF
96way 3Pole	GB2-9618-3TF

General Accessories

Pole Capacity	Catalogue No.
Tee-off Cap	GBTOC
Toggle joining bar 3P	GBTB3
Din through terminal 100A	DINTT100A

Concept Escutcheons

Description	Catalogue No.
Escutcheons- to suit stockboards (comes complete with hinge and fastening screws)	
Escutcheon 24 way 3M-648mm White	CELES3D24AP
Escutcheon 36/48 way 4M-864mm White	CELES4D48AP
Escutcheon 60 way 5M-1080mm White	CELES5D60AP
Escutcheon 72/84 way 6M-1296mm White	CELES6D84AP
Escutcheon 96 way 7M-1512mm White	CELES7D96AP
Escutcheons- Horizontal cut-out (comes complete with hinge and fastening screws)	
Escutcheon 24 way 1 row 24ways 2M-432mm White	CELES224ACCAP
Escutcheon 48 way 2 rows 24ways 2M-432mm White	CELES248ACCAP
Escutcheon 72 way 3 rows 24ways 3M-648mm White	CELES372ACCAP
Escutcheons- Blank (comes complete with hinge and fastening screws)	
Escutcheon blank 1M-216mm White	CELES1NAP
Escutcheon blank 2M-432mm White	CELES2NAP
Escutcheon blank 3M-648mm White	CELES3NAP
Escutcheon blank 4M-864mm White	CELES4NAP
Escutcheon blank 5M-1080mm White	CELES5NAP
Escutcheon blank 6M-1296mm White	CELES6NAP
Escutcheon blank 7M-1512mm White	CELES7NAP
Escutcheon blank 8M-1728mm White	CELES8NAP
Escutcheon blank 9M-1944mm White	CELES9NAP
Escutcheons- LOCKDIN (comes complete with hinge and fastening screws)	
Escutcheon 24 way LOCKDIN 3M-648mm White	CELES3D24LAP
Escutcheon 36/48 way LOCKDIN 4M-864mm White	CELES4D48LAP
Escutcheon 60/72 way LOCKDIN 5M-1080mm White	CELES5D60LAP
Escutcheon 84 way LOCKDIN 6M-1296mm White	CELES6D84LAP
Escutcheon 96 way LOCKDIN 7M-1512mm White	CELES7D96LAP
Escutcheons- X-Row (comes complete with hinge and fastening screws)	
Escutcheon X-ROW 30 way 4M-864mm White	CELES4D30H1AP
Escutcheon X-ROW 48 way 5M-1080mm White	CELES5D48H1AP
Escutcheon X-ROW 72 way 7M-1512mm White	CELES7D72H1AP
Escutcheon X-ROW 96 way 8M-1728mm White	CELES8D96H1AP

Concept Escutcheons

Description	Catalogue No.
Escutcheons- Concept Premier GB locking (comes complete with hinge and fastening screws)	
Escutcheon 12 way GB lockout Mechanism 3M-648mm White	CELES3G12LAP
Escutcheon 24 way GB lockout Mechanism 3M-648mm White	CELES3G24LAP
Escutcheon 36 way GB lockout Mechanism 4M-864mm White	CELES4G36LAP
Escutcheon 48 way GB lockout Mechanism 4M-864mm White	CELES4G48LAP
Escutcheon 60 way GB lockout Mechanism 5M-1080mm White	CELES5G60LAP
Escutcheon 72 way GB lockout Mechanism 6M-1296mm White	CELES6G72LAP
Escutcheon 84 way GB lockout Mechanism 6M-1296mm White	CELES6G84LAP
Escutcheon 96 way GB lockout Mechanism 7M-1512mm White	CELES7G96LAP

All escutcheons are white and come complete with hinges and fasteners

Concept technical

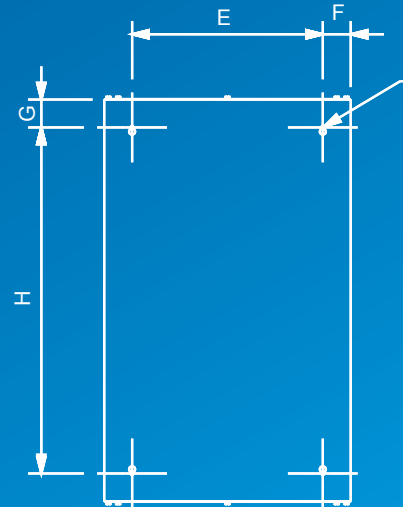
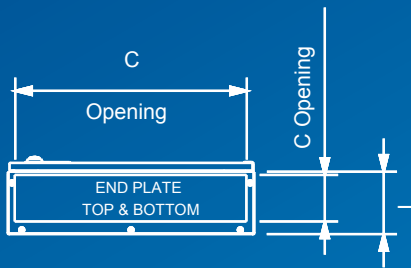
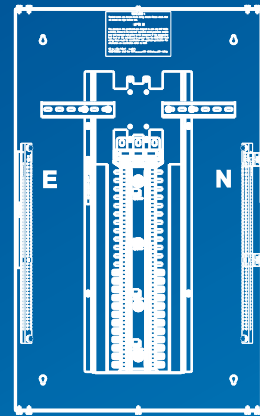
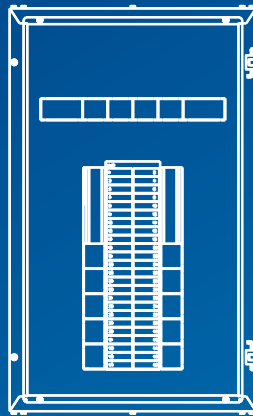
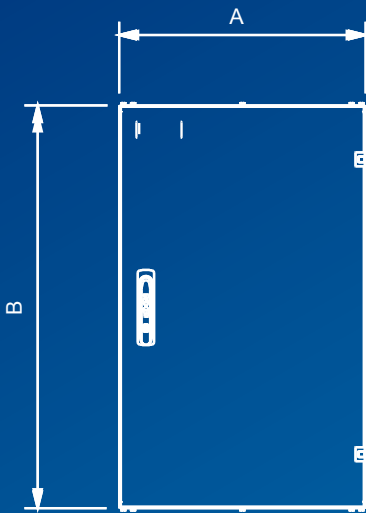

Concept One

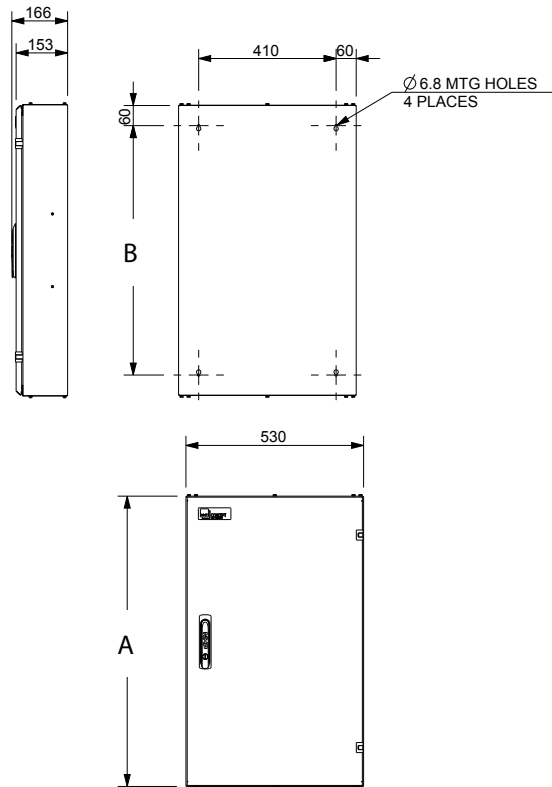

Mounting dimensions

Module size	A	B
2	432mm	312mm
3	648mm	528mm
4	864mm	744mm
5	1080mm	960mm
6	1296mm	1176mm

Concept Plus

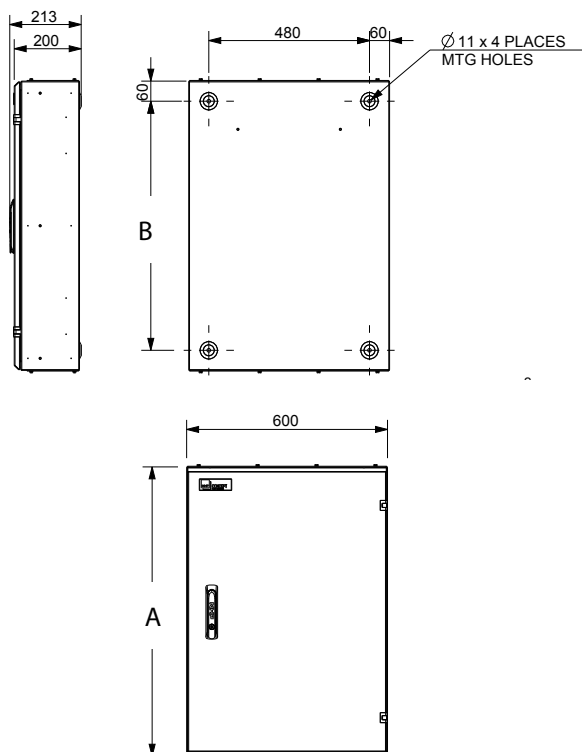

Mounting dimensions

Module size	A	B
2	432mm	312mm
3	648mm	528mm
4	864mm	744mm
5	1080mm	960mm
6	1296mm	1176mm
7	1512mm	1392mm
8	1728mm	1608mm
9	1944mm	1824mm

Plan view

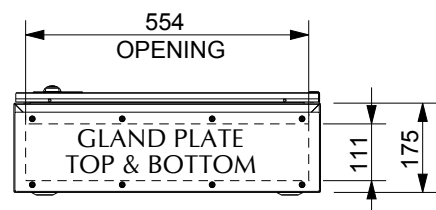

Concept Premier

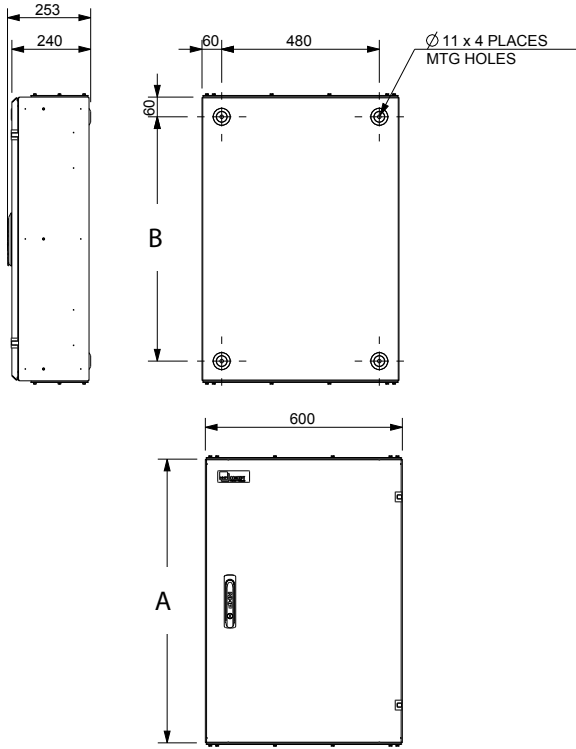

Mounting dimensions

Module size	A	B
2	432mm	312mm
3	648mm	528mm
4	864mm	744mm
5	1080mm	960mm
6	1296mm	1176mm
7	1512mm	1392mm
8	1728mm	1608mm
9	1944mm	1824mm

Plan view

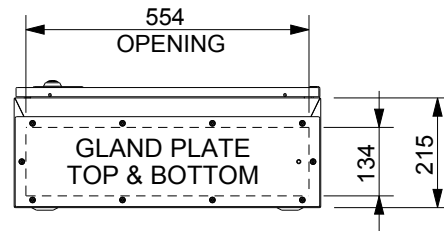

Concept Tough

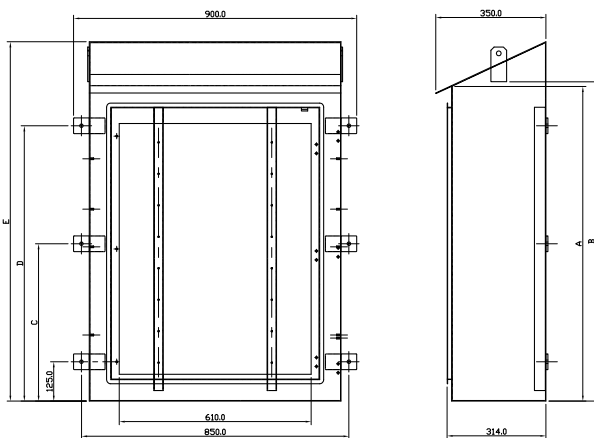

Mounting dimensions

Box size	A	B	C	D	E
Size 2	1000	1015	-	750	750
Size 3	1500	1515	750	1375	750
Size 4	2000	2015	1000	1875	2142

Plan view

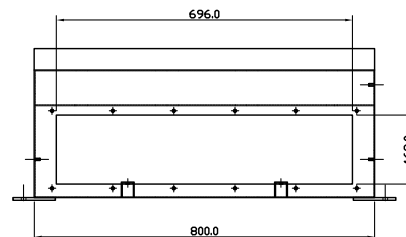



The Power of Local. The Power of NHP

No matter how good a product may be, it is nothing without dedicated people to support that product - and at NHP, we have you covered. Our strength lies in providing choice to our customers – be that choice in product, choice in technology or choice in service and support, the kind of choice you only get from a local provider.

Throughout the entirety of the manufacturing process, our agile framework means we can adapt with the local market and our commitment to a personalised service ensures you can expect a dedicated point of contact throughout your project. Aligning with the integrity of the design process our manufacturing process brings the highest levels of quality assurance and testing, safety, standards compliance and production quality.

Victorian Manufacturing Hall of Fame

In 2012 NHP became proud inductees into the Victorian Manufacturing Hall of Fame which acknowledges those who have displayed a sustained contribution to manufacturing excellence. Established in 2001, the Victorian Manufacturing Hall of Fame recognises companies and individuals who have the dedication, creativity and energy to take Victorian manufacturing to the next level.



Why Choose NHP

Think local, increased choice and customisation. Think NHP.

Founded in 1968 NHP has almost 50 years of experience with power distribution and motor control technology and applications. We are committed to providing customers with internationally recognised products backed by local expertise, extensive stock holding and professional service.

We are proud to continue the core focus of our heritage, servicing our customers in conjunction with a vast global network of supply partners that enable us to bring the world's best products and solutions to the local market, customised to suit local applications.

With local teams across Australia and New Zealand, NHP's expertise and support offering is strengthened by long standing global partnerships with world class supply line partners.

For your next project, think NHP.



Customised manufactured solutions that add value



Our National Manufacturing and Distribution Centre in Laverton, Victoria highlights NHP's commitment and expertise in local manufacturing. At this state-of-the-art facility, our expert team brings together a range of manufacturing services under one roof enabling us to provide our customers with the service they require to meet their varied objectives.

At NHP we are dedicated to providing an end-to-end manufacturing service that brings together a range of value-add services extending far beyond the assembly itself. These services instill confidence across the lifespan of a project and ultimately enables customers to increase their efficiencies as well as lower the total cost to manufacture through a reduction in the build and commissioning time.

Value Add Services:

- Consulting
- Design
- Processes and Production
- Project Management
- Engineering
- Quality and Compliance

Key manufacturing solution groups:

- Power Distribution
- Energy Management
- Motor Control and Automation
- Hazardous Environments

AUSTRALIA

nhp.com.au

SALES 1300 NHP NHP

sales@nhp.com.au

NEW ZEALAND

nhp-nz.com

SALES 0800 NHP NHP

sales@nhp-nz.com



NHP Electrical Engineering Products

A.B.N. 84 004 304 812

NHP99723 - 07/18

© Copyright NHP 2018



Environmentally Friendly
Printed on recycled paper



For more information, scan to download the NHP eCatalogues App offering exclusive video content, catalogues and literature